

Power Distribution Panel User's Guide

Rev 1.0



Cross The Road Electronics

www.crosstheroadelectronics.com

Table of Contents

1. Power Distribution Panel at a Glance	3
1.1. Connection Specifications	4
1.2. Electrical Specifications	5
1.3. Mechanical Specifications	5
1.4. Communication Specifications	5
2. Installing a PDP	6
2.1. Battery harness	6
2.2. Breakers	7
2.2.1. Snap Action 40 Amp Breaker	7
2.2.2. Snap Action 20/30 Amp Breaker	8
2.3. Weidmuller Connectors	9
2.3.1. roboRIO, PCM, VRM.....	10
2.3.2. CAN bus	11
3. LED States.....	12
4. Revision History	13

1. Power Distribution Panel at a Glance

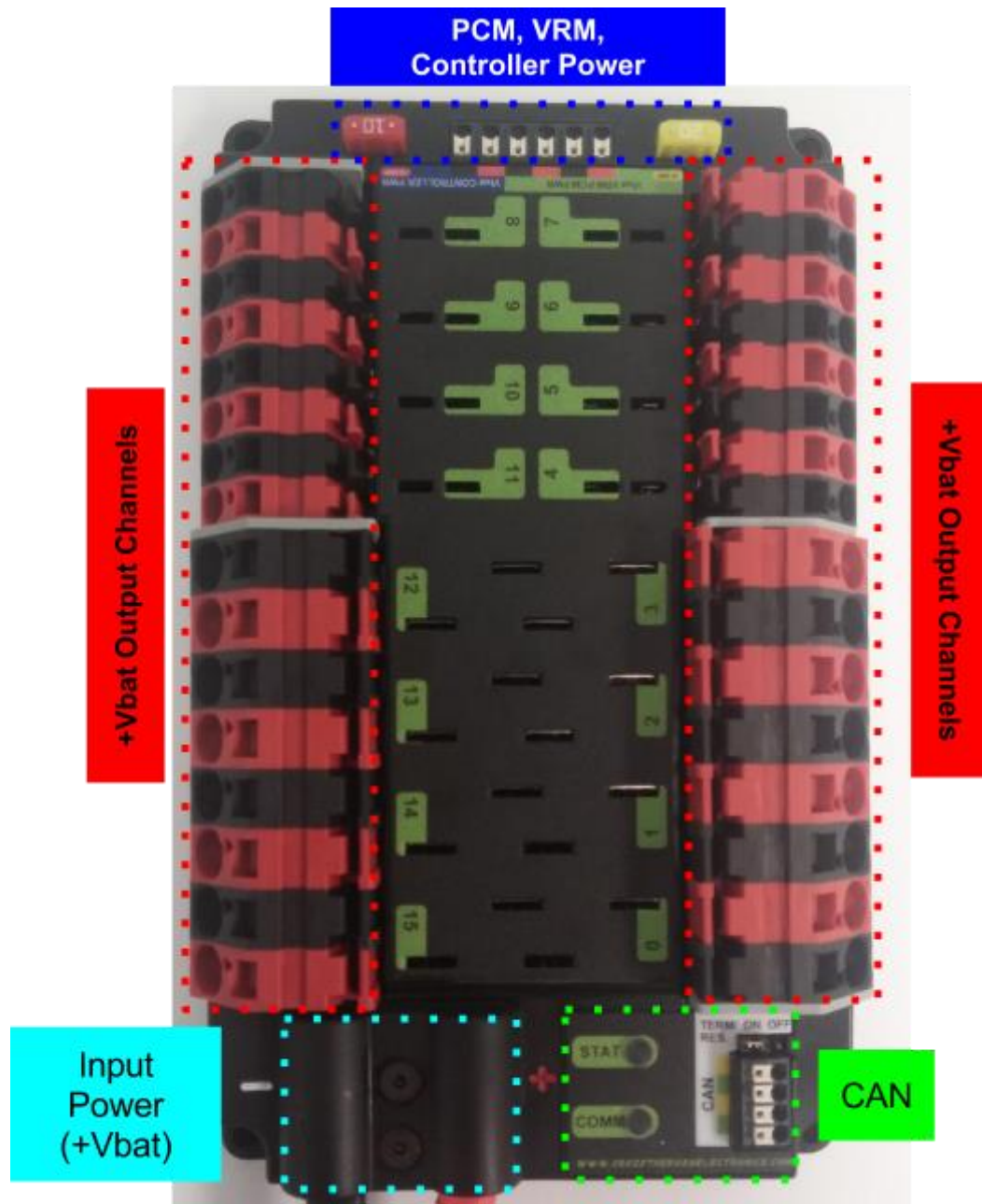

1.1. Connection Specifications

- **Battery**
 - Bushings Lugs x 2
 - Thread M6x1

- **Power Channels (All Channels provide battery power)**
 - WAGO Connectors
 - 8 Red Channels 4-11
 - 30 Amp
 - 8 Red Channels 0-3, 12-15
 - 40 Amp
 - Black terminals are common

 - 6 Position Weidmuller Connector
 - PCM, VRM Supply
 - 20 Amp fused
 - roboRIO Supply
 - 10 Amp fused
 - **Max:** 16 AWG
 - **Min:** 24 AWG

See [Section 2.3. Weidmuller Connectors](#) for wire insert instructions.

- **CAN**
 - 4 Position Weidmuller Connector
 - Yellow CAN High x 2
 - Green CAN Low x 2

1.2. Electrical Specifications

Input Voltage (Vbat)	5.5-16 V
Absolute Max Input Voltage⁽¹⁾	20 V
Output Voltage	
<ul style="list-style-type: none"> • Channels 0-3, 12-15 	Vbat - 40 A
<ul style="list-style-type: none"> • Channels 4-11 	Vbat - 20 or 30 A
<ul style="list-style-type: none"> • VRM, PCM Weidmuller 	Vbat - 20 A fused
<ul style="list-style-type: none"> • Controller Weidmuller 	Vbat - 10 A fused

Note 1: Stresses above those listed under "Absolute Maximum Ratings" may cause permanent damage to the device. This is a stress rating only and functional operation of the device at those or any other conditions above those indicated in the operation listings of this specification is not implied. Exposure to maximum rating conditions for extended periods may affect device reliability.

1.3. Mechanical Specifications

Length	7.586 in.
Width	4.748 in.
Height	1.422 in.
Weight	1 lb. 5.3 oz.

1.4. Communication Specifications

Baud Rate	1 MB/s
CAN Termination	120 Ohm (jumper placed in the ON position). None (jumper missing or placed in the OFF position).
CAN High / Low	2 Ports

2. Installing a PDP

2.1. Battery harness

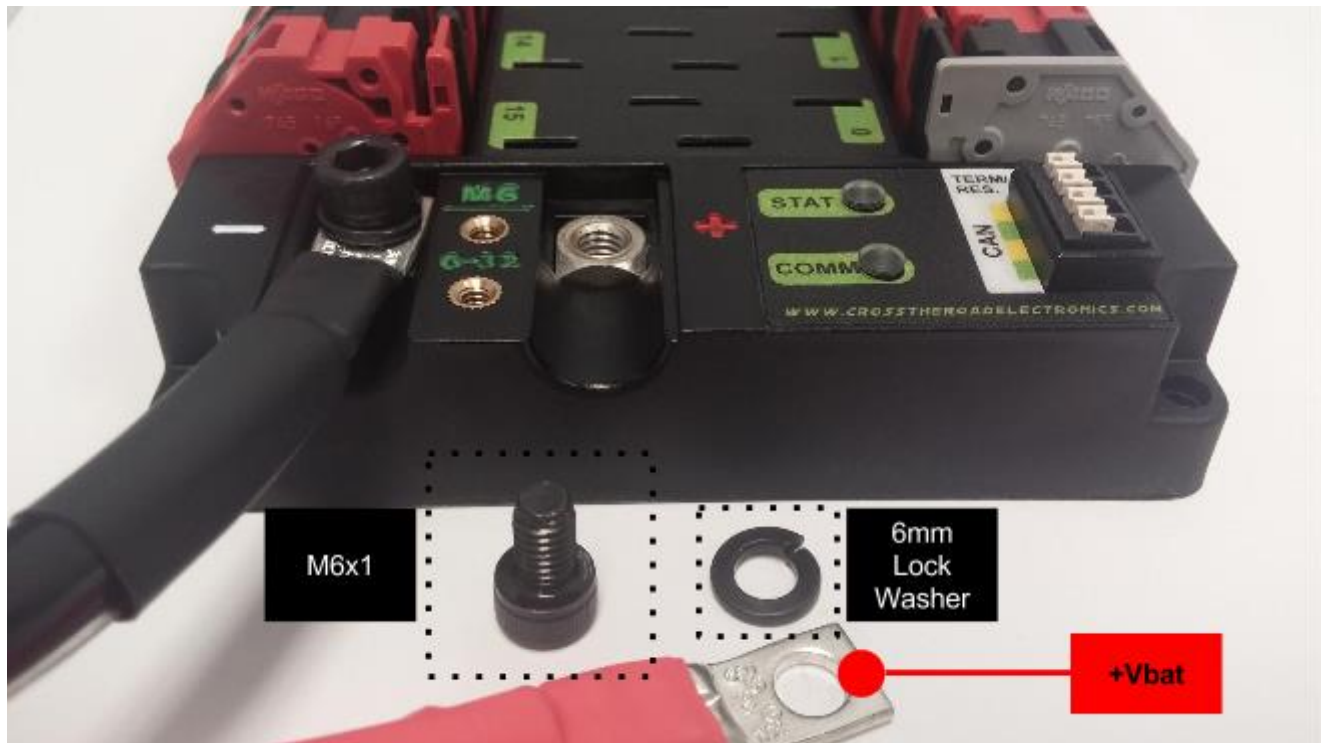

- Requirements
 - 2 - M6x1 Bolts
 - 2 - 6mm Split (Lock) Washers
 - 12 Volt Supply (Battery, Power Supply, etc.)

2.2. Breakers

2.2.1. Snap Action 40 Amp Breaker

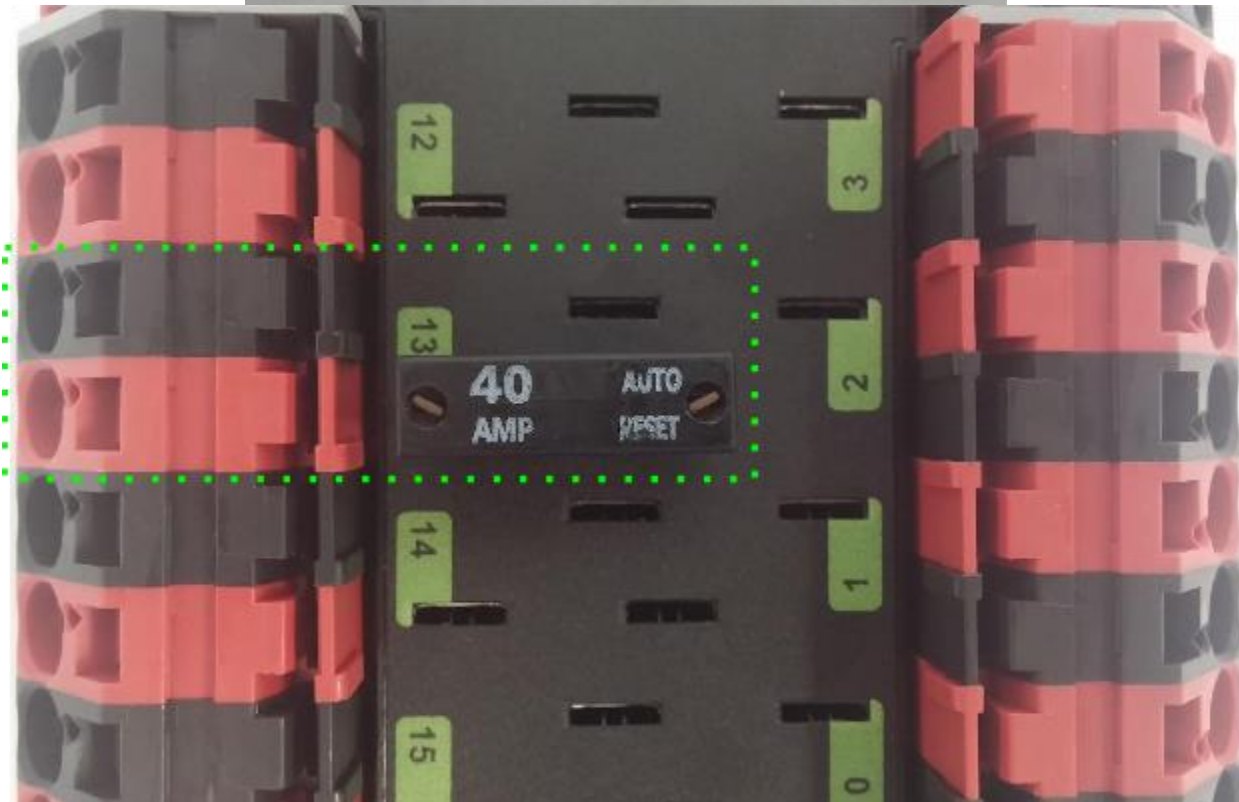
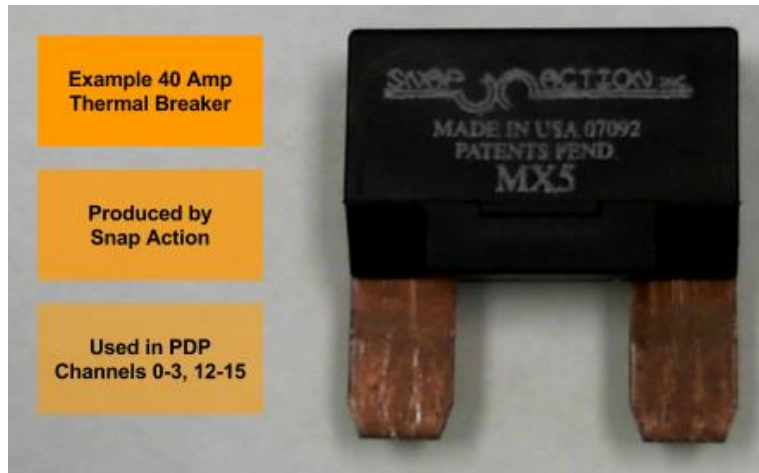

- Channels 0-3, Channels 12-15
 - 40 Amp Breaker
 - Limits Closest Red WAGO
 - Supplies Battery Power

2.2.2. Snap Action 20/30 Amp Breaker

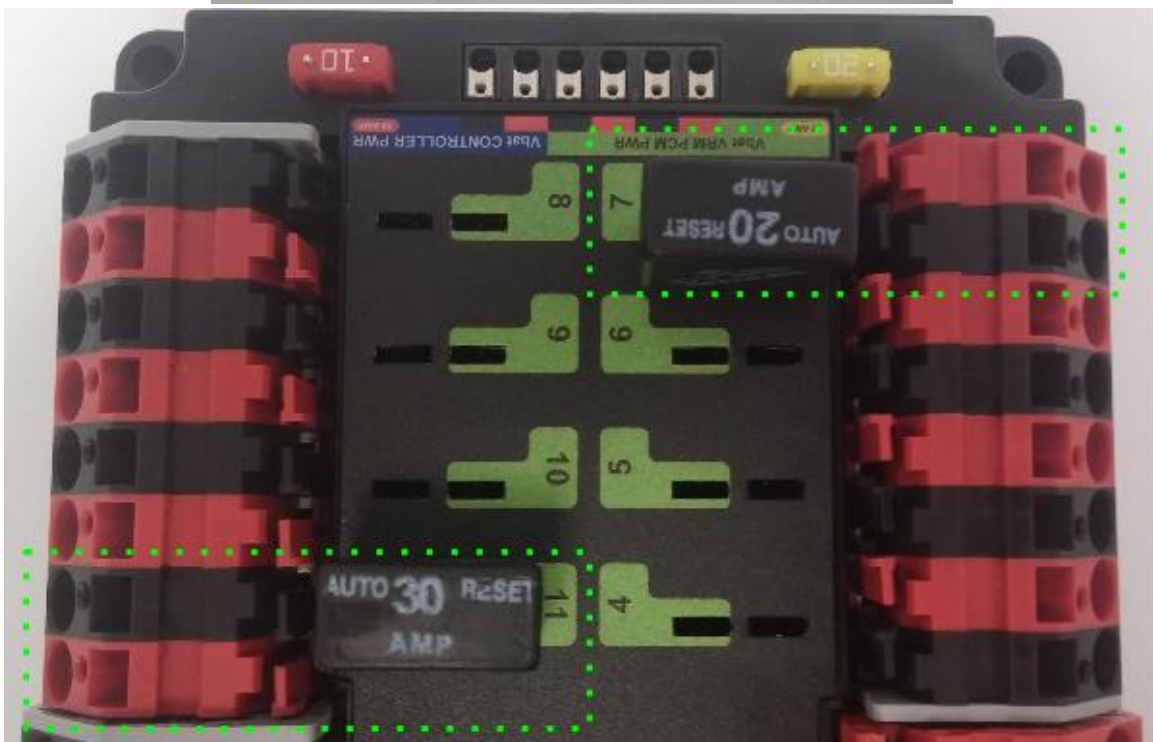

- Channels 4-11
 - 30 or 20 Amp Breaker
 - Limits Closest Red WAGO
 - Supplies Battery Power

2.3. Weidmuller Connectors

Wire Insertion

- Disconnect PDP from Battery before adding or modifying connections
- Strip wire back **~0.375" (3/8")**
- Press and hold down connector button. Though this isn't necessary, it ensures the stripped wire does not deform and split into "whiskers" after excessive use. A small screwdriver can be used to easily hold down the connector button.
- Insert wire into connector opening
- Release connector button
- Pull wire to ensure wire is locked in connector
- Confirm wire strands are not extruded

Wire Inspection

- Verify that there are no "whiskers" outside of the connector that may cause a short.
- Verify that the stripped portion of the wire is not excessive enough to cause a short.
- Tug on the wire and verify wire does not pull out. If it does then recheck gauge and/or strip the wire back further.

Wire Removal

- Press and hold down connector button immediately above connector opening
- Pull wire to remove from connector

Limitations

- Wire should **not be frayed** upon insertion. Extruded wire may short to adjacent channels.
- Wire should be **no larger than 16 AWG**, larger gauges will not properly fit in connector
- Wire should be **no smaller than 24 AWG**, smaller gauges will not lock in connector

2.3.1. roboRIO, PCM, VRM

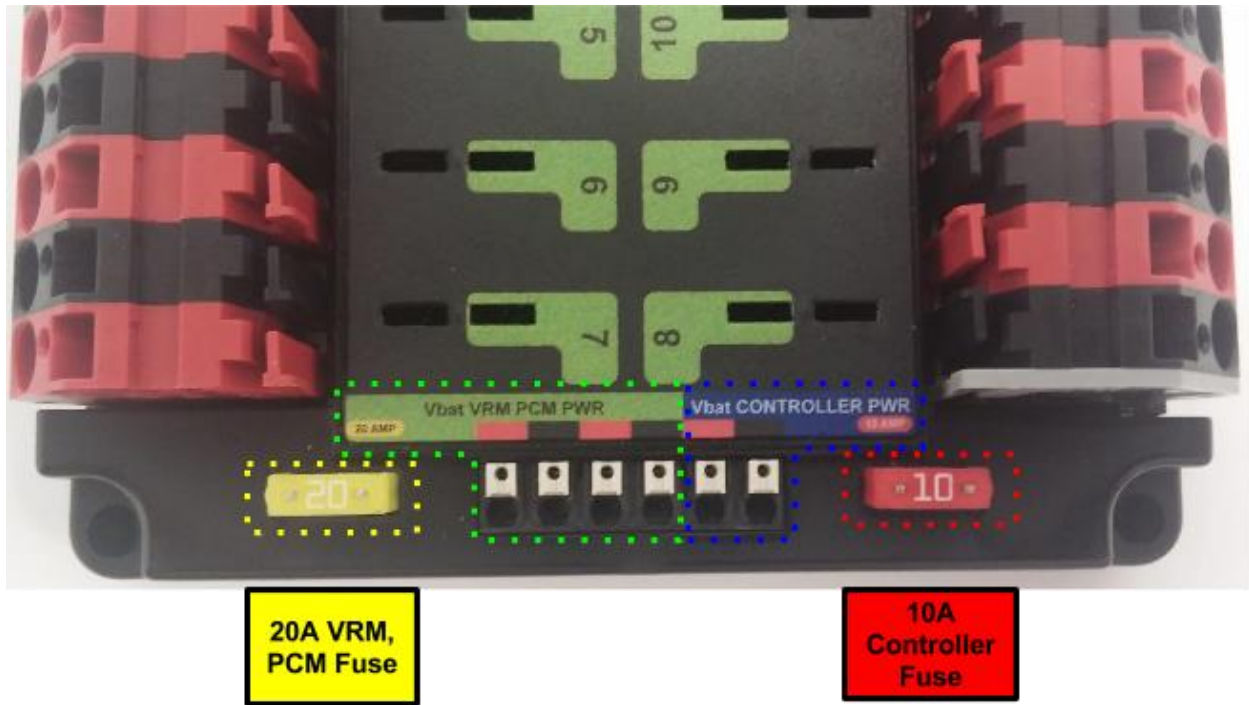

Weidmuller Connectors are used for connecting the roboRIO, PCM, and VRM modules to power. See [Section 2.3. Weidmuller Connectors](#) for wire insertion and removal procedures.

2.3.2. CAN bus

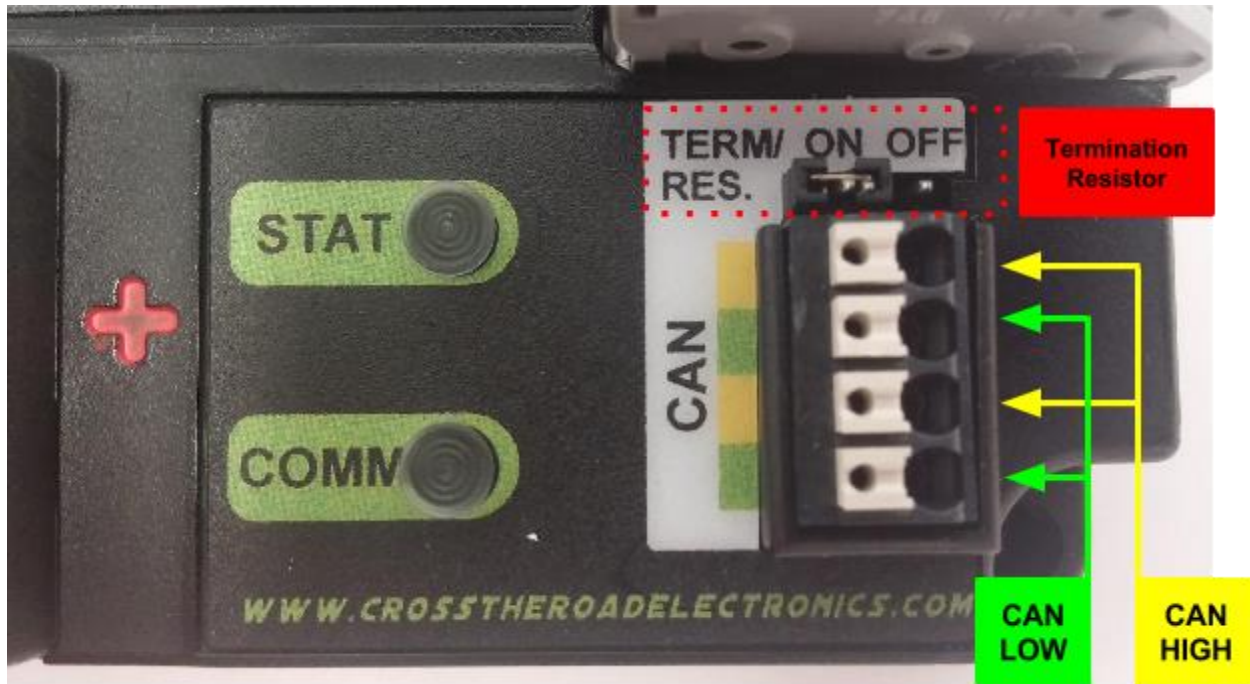

Weidmuller Connectors are also used for CAN Communication. See [Section 2.3. Weidmuller Connectors](#) for wire insertion and removal procedures. Smart Module provides termination and may be placed at the end of CAN bus chain.

Termination Resistor Jumper

- Only place the jumper to the ON position when PDP is at the **end** of the CAN bus.
- **ON State** - Positioning the jumper closest to the inside of the PDP (shown above).
- **OFF State** - Positioning the jumper closest to the edge of the PDP or removing the jumper.

3. LED States

The STAT and COMM LEDs are multi-color LEDs that can blink green, orange, or red.



The two LEDs are always the same color/blink pattern. The only exception to this is when the device is in boot-loader.

LED Blink/Color	Description
Fast Green Blink	Robot is enabled.
Slow Green Blink	Robot is disabled.
Slow Orange Blink	Robot is disabled. Sticky Fault present.
Slow Red Blink	No CAN Comm.
(COMM LED only) Green/Orange Blink	Device is in boot-loader. Field-upgrade necessary.
Both LEDs off	Device is NOT powered.

4. Revision History

Rev	Date	Description
1.0	30-Dec-14	Initial Creation